

General Description

KR Electronics part number 3410-65-SMA is a 65 MHz band-pass filter. The filter has a min 3 dB bandwidth of 110 MHz. Other center frequencies and are bandwidths available. Please consult the factory.

Features

- 65 MHz Bandpass
- 3 dB Bandwidth 110 MHz min
- 40 dB Bandwidth 131 MHz max
- Stopband to 6 GHz
- Selective Elliptic Type Filter
- 50 Ω Source and Load
- SMA Connectors

Typical Performance

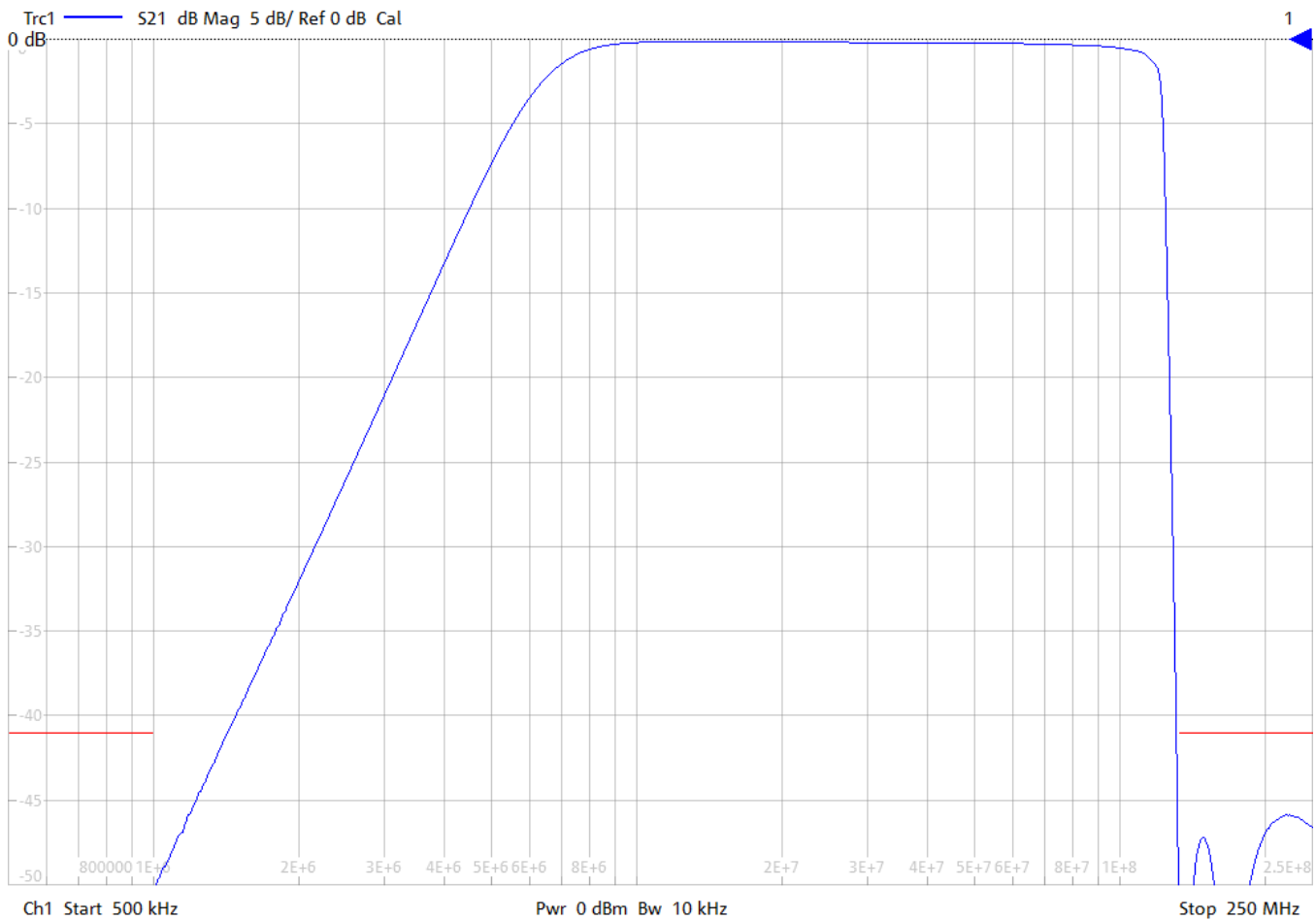

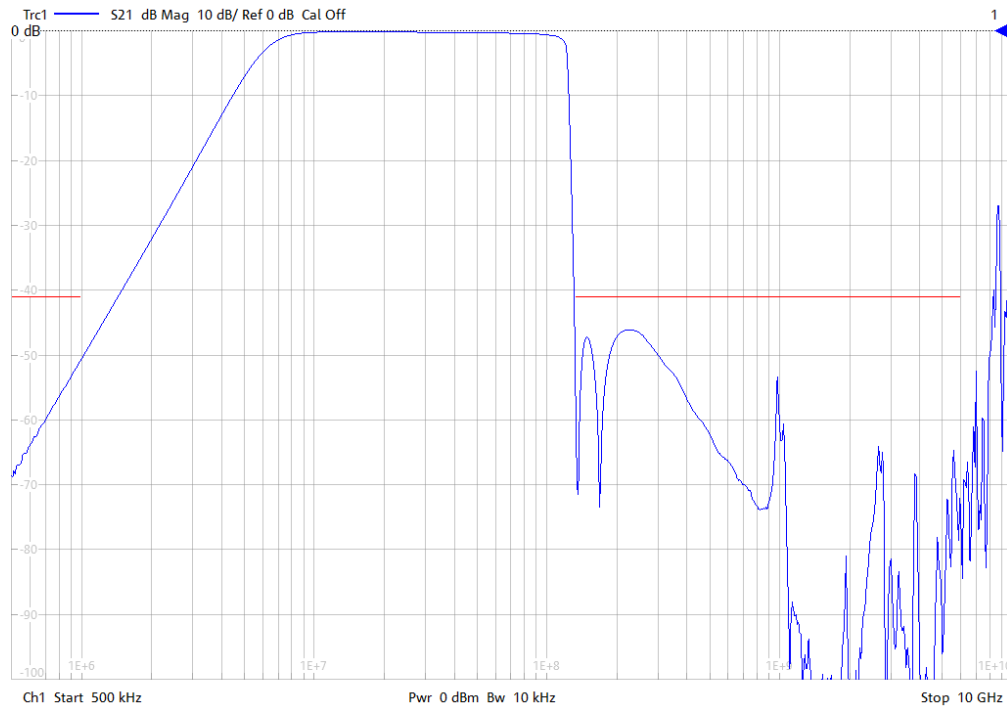
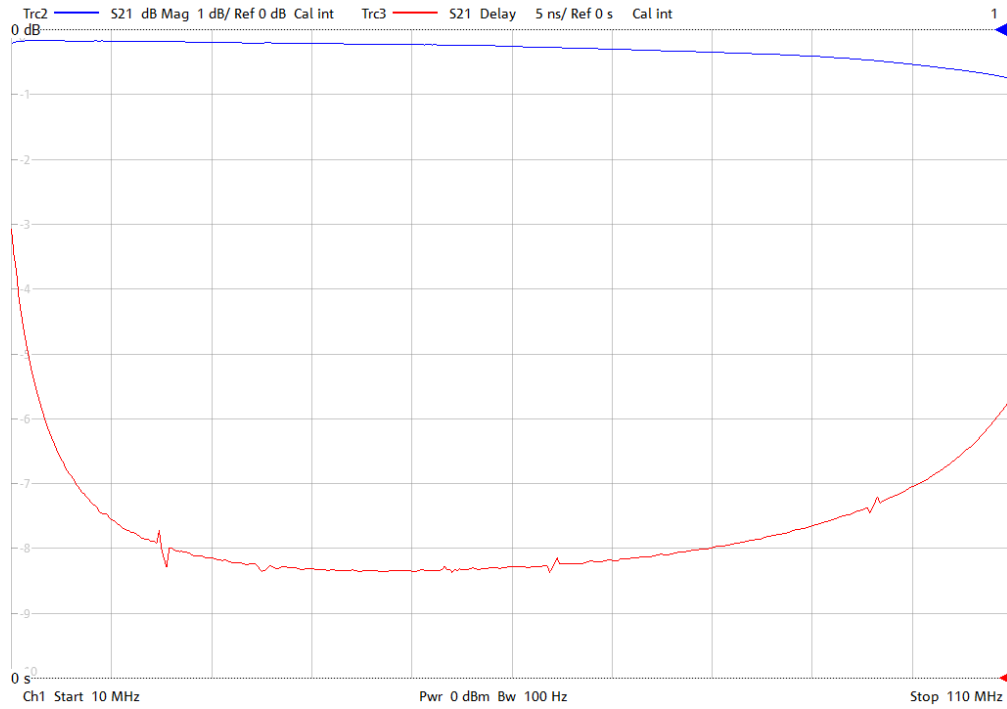

KR Electronics, Inc.
 91 Avenel Street
 Avenel, NJ 07001

Web www.krfilters.com
 Email sales@krfilters.com
 Phone (732) 636-1900
 Fax (732) 636-1982

KR Electronics 3410-65-SMA

Specifications

Parameter	Specification	
Filter type	Bandpass	
Center Frequency	65 MHz	
Insertion Loss	1 dBa max	0.3 dBa typical
3 dBc Bandwidth	110 MHz min	10 to 120 MHz
Rejection at 1 MHz & below	40 dBc min	
Rejection at 132 to 6000 MHz	40 dBc min	
Source and Load	50 Ω	

Physical Dimensions

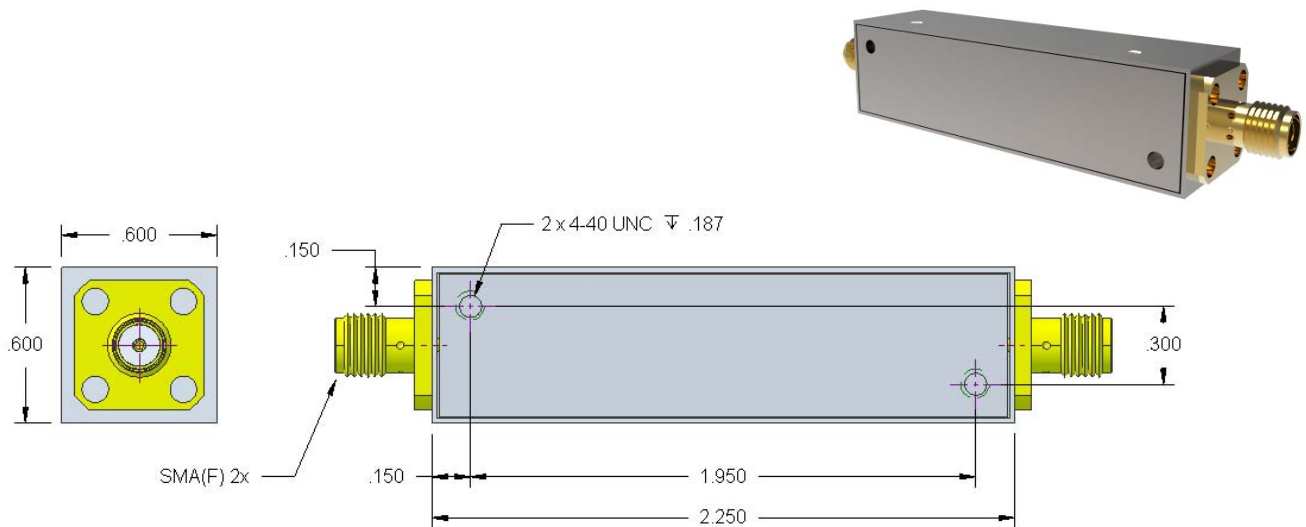

Notes:

1. Dimensions in inches
2. Metal Case
3. SMA(F) Connectors

KR Electronics, Inc.
91 Avenel Street
Avenel, NJ 07001

Web www.krfilters.com
Email sales@krfilters.com
Phone (732) 636-1900
Fax (732) 636-1982