

KR Electronics, Inc.

General Description

KR Electronics part number 3212-232.5+ is a 232.5 MHz band-pass filter. Other frequencies are available. Please consult the factory.

Features

- 232.5 MHz Bandpass Filter
- 3 dB Bandwidth 76 MHz typical
- 50 Ω Source and Load
- Surface Mount

Typical Performance

Overall Response (10 dB/div)



KR Electronics, Inc.
91 Avenel Street
Avenel, NJ 07001

Web www.krfilters.com
Email sales@krfilters.com
Phone (732) 636-1900
Fax (732) 636-1982

KR Electronics 3212-232.5+

Passband Amplitude & Return Loss (1 dB/div & 5 dB/div)

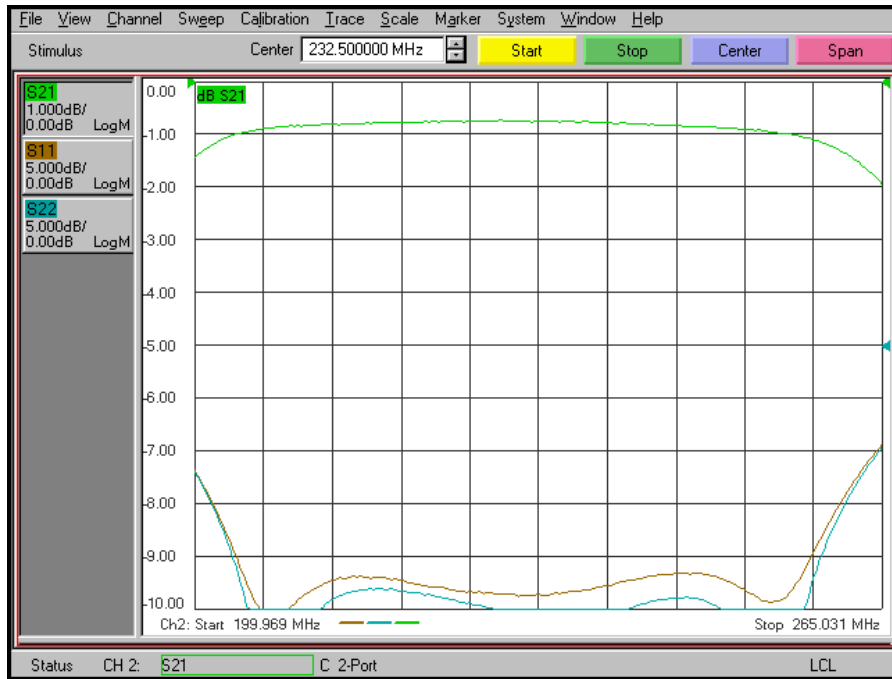

Overall Response (10 dB/div)



KR Electronics, Inc.
91 Avenel Street
Avenel, NJ 07001

Web: www.krfilters.com
Email: sales@krfilters.com
Phone: (732) 636-1900
Fax: (732) 636-1982

KR Electronics 3212-232.5+

Specifications

Parameter	Specification	Notes
Filter type	Bandpass	
Center Frequency	232.5 MHz	
Insertion Loss	2 dBa max	0.8 dBa typical
1 dB Bandwidth	45 MHz min	65 MHz typical
3 dB Bandwidth	76 MHz typical	
Rejection at 158 MHz & 255 MHz	25 dB min	
40 dB Bandwidth	215 MHz typical	
50 dB Bandwidth	270 MHz typical	
Source and Load	50 Ω	

Physical Dimensions

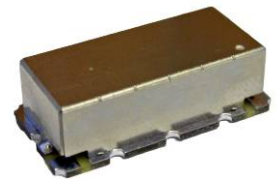
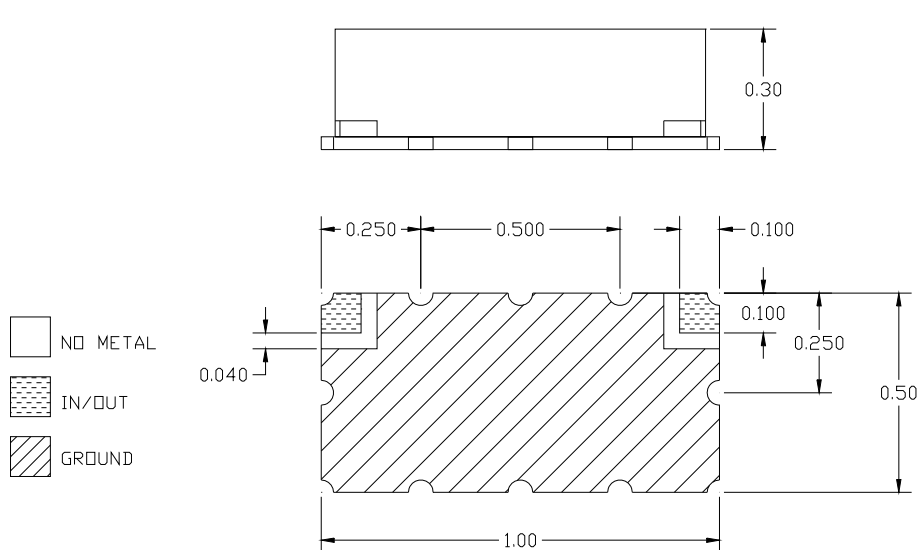

Notes:

1. Surface mount package
2. Dimensions in inches
3. Max reflow temperature 230° C for 10 sec
4. If boards are cleaned after installation units must be completely dried