

KR Electronics, Inc.

General Description

KR 2830 is a 60 MHz surface mount bandpass filter. Other frequencies and bandwidths available. Please consult the factory.

Features

- 60 MHz Bandpass Filter
- Elliptic Response
- Surface Mount Package
- 50 Ω Source and Load

Typical Performance

Passband Amplitude & Group Delay (1 dB/div & 5 nsec/div)

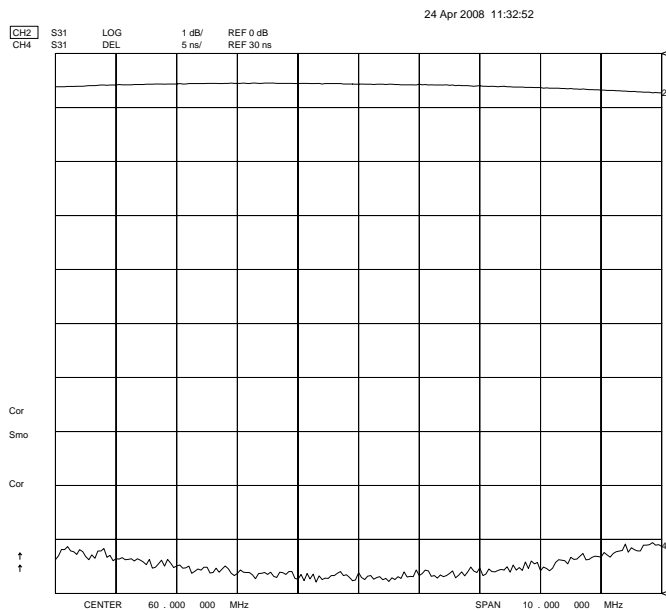

Overall Response (5 dB/div)

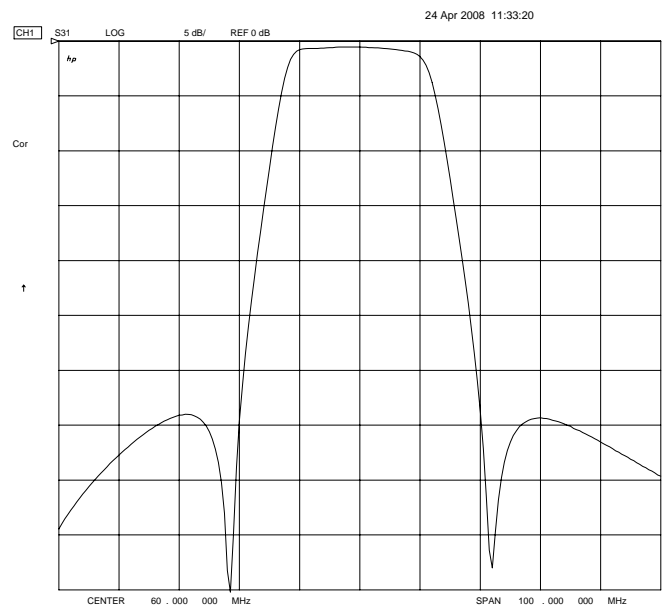

KR Electronics, Inc.
91 Avenel Street
Avenel, NJ 07001

Web www.krfilters.com
Email sales@krfilters.com
Phone (732) 636-1900
Fax (732) 636-1982

KR 2830 Bandpass

Specifications

Parameter	Specification
Filter type	Bandpass
Center Frequency	60 MHz
1 dB Bandwidth	10 MHz min (21 MHz typical)
Attenuation at 40 MHz	25 dB min
Attenuation at 80 MHz	25 dB min
Source and Load	50 Ω

Physical Dimensions

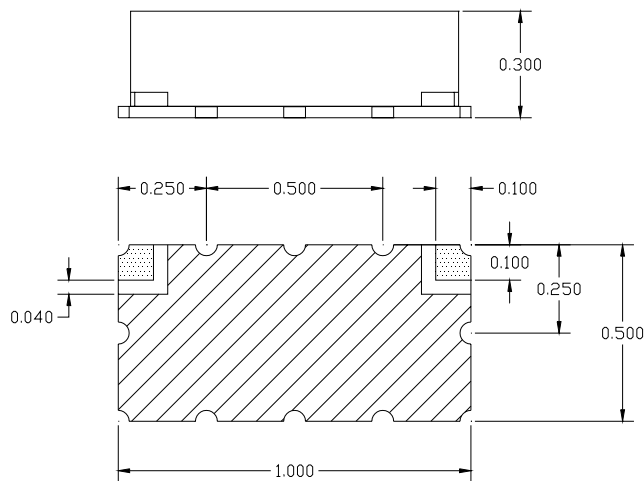

Notes:

1. Surface mount package — Metal cover, open frame
2. Dimensions in inches
3. Max reflow temperature 209° C for 10 sec
4. If boards are cleaned after installation, units must be completely dried