

KR 2618-1 Bandpass Filter

General Description

KR 2618-1 is a 92 MHz surface mount bandpass filter. Other center frequencies and bandwidths available. Please consult the factory.

Features

- Surface Mount Package
- 50 Ω Source and Load

Typical Performance

Passband Amplitude & Group Delay
(1 dB/div & 10 nsec/div)

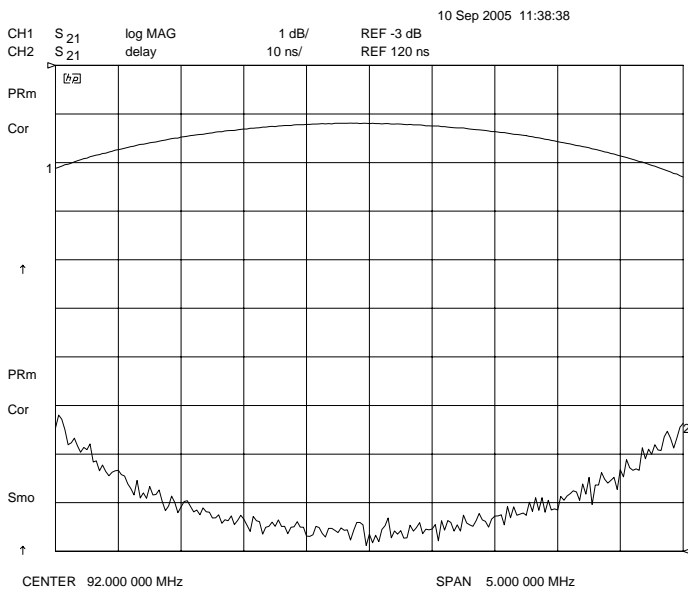

Overall Response
(10 dB/div)

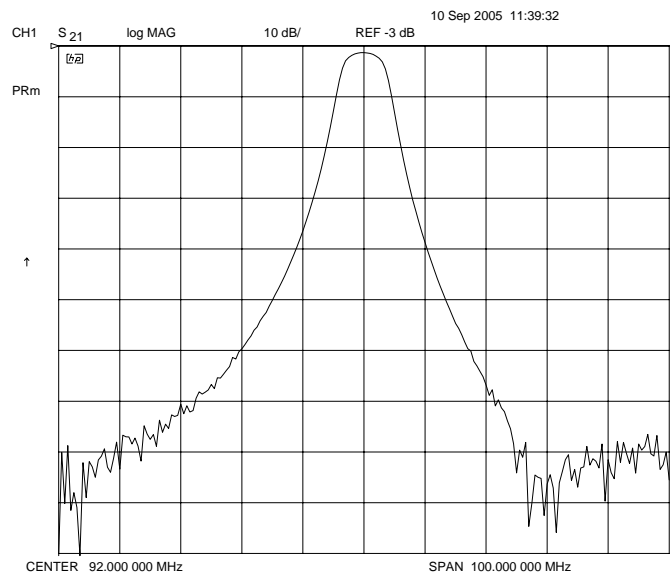

KR Electronics, Inc.
91 Avenel Street
Avenel, NJ 07001

Web www.krfilters.com
Email sales@krfilters.com
Phone (732) 636-1900
Fax (732) 636-1982

KR 2618-1 Bandpass

Specifications

Parameter	Specification
Filter type	Bandpass
Center Frequency	92 MHz
Insertion Loss	< 6 dB (4 dB typical)
1 dB Bandwidth	> ± 2 MHz
Source and Load	50 Ω

Physical Dimensions

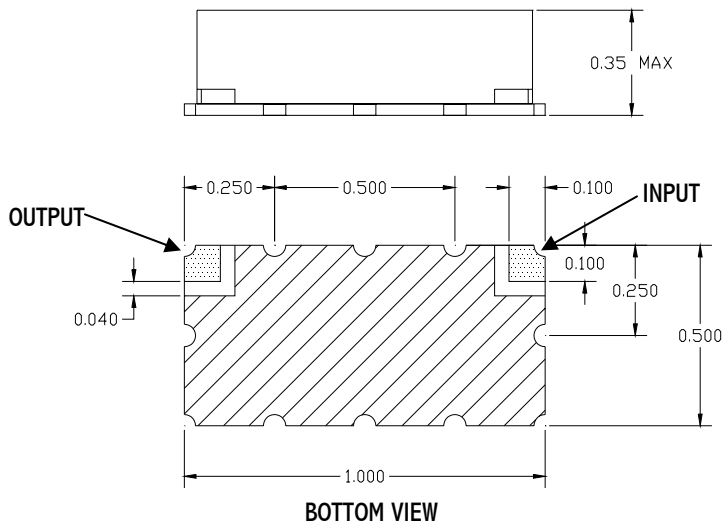

Notes:

1. Surface mount package — Metal cover, open frame
2. Dimensions in inches
3. Use SN60 or SN63 solder during installation
Max Reflow temperature 205° C for 15 sec
4. If boards are cleaned after installation, units must be completely dried to remove any entrapped moisture that will effect electrical performance